

KTL0250xx3

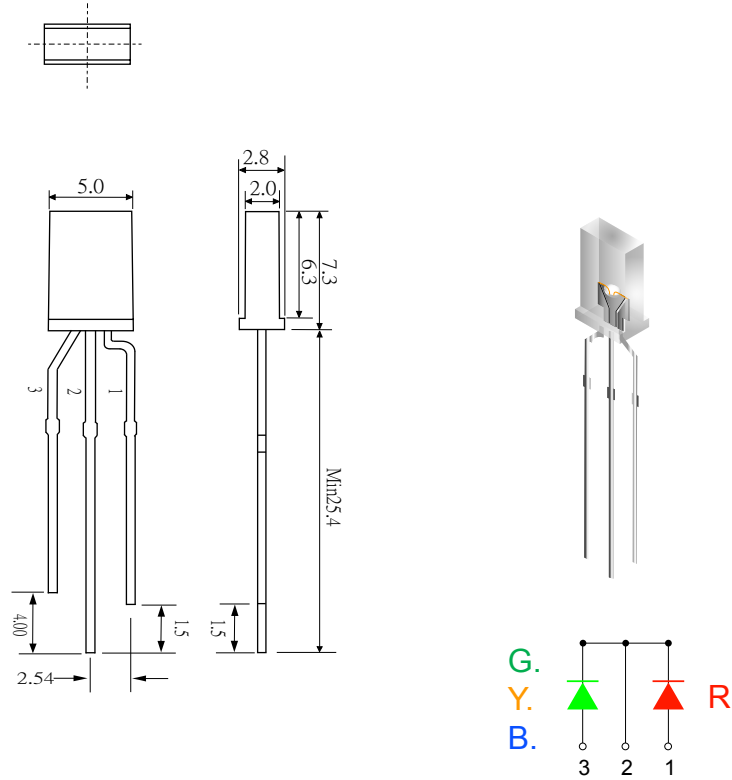

Part no.	Colour	Wave Length	Lens Color (x)	Luminous Intensity (mcd)	Forward Voltage (V)	Forward Current (mA)	0°
KTL0250DKxI-3	Red	632		500	2.15	20	30
	Green	565		500	2.15	20	30
KTL0250CJxI-3	Red	632		1500	2.15	20	30
	Green	565		1500	2.15	20	30
KTL0250AJxI-3	Red	632		2500	2.15	20	30
	Green	565	W- White	2500	2.15	20	30
KTL0250CIxI-3	Red	632	C - Water Clear	1500	2.15	20	30
	Yellow	589		1300	2.15	20	30
KTL0250AIxI-3	Red	632		2500	2.15	20	30
	Yellow	589		2500	2.15	20	30
KTL0250CBHxI-3	Red	632		1500	2.15	20	30
	Blue	470		1600	3.60	20	30
KTL0250ABUxI-3	Red	632		2500	2.15	20	30
	Blue	470		3500	3.60	20	30