

GU10-1FRD3W

Features

- * Aluminum housing
- * CE approved
- * Eco-product
- * Extended longer life
- * High luminance
- * Low power consumption
- * RoHS compliant
- * Well heat sink
- * Wide viewing angle

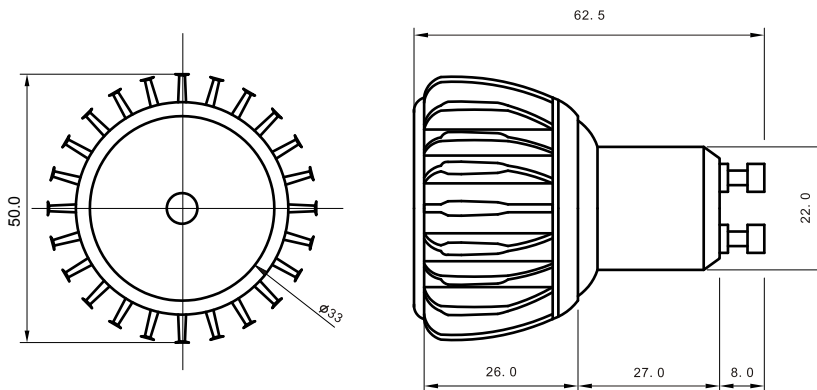

Specifications

Base type	GU10
Forward Current	350mA
Input voltage	AC 85-220V,50/60Hz
Light source	1x3W power LED
Color	Red
Luminous Intensity	70-80Lm
Operating temperature	-40-+70deg
Size	50x63mm
Viewing angle	45deg
Weight	50g

Important:

- * Bulb electricity is compatible with the light socket voltage.
- * The power is off while plug the light bulb into the socket.
- * Suitable for dimmer switches or remote controls.
- * Specified performance measured in 85-220V range.
- * Do not look permanently to the light sources.

