

JDRE27-1CYW3W

Features

- * Aluminum housing
- * CE approved
- * Eco-product
- * Extended longer life
- * High luminance
- * Low power consumption
- * RoHS compliant
- * Well heat sink
- * Wide viewing angle

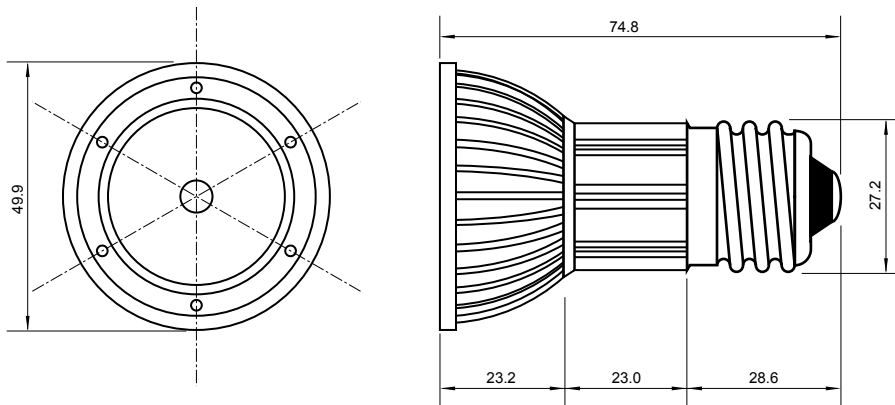

Specifications

| | |
|-----------------------|--------------------|
| Base type | JDRE27 |
| Forward Current | 700mA |
| Input voltage | AC 85-220V,50/60Hz |
| Light source | 1x3W power LED |
| Color | Yellow |
| Luminous Intensity | 65-75Lm |
| Operating temperature | -40-+70deg |
| Size | 50x60mm |
| Viewing angle | 45deg |
| Weight | 60g |

Important:

- * Bulb electricity is compatible with the light socket voltage.
- * The power is off while plug the light bulb into the socket.
- * Suitable for dimmer switches or remote controls.
- * Specified performance measured in 85-220V range.
- * Do not look permanently to the light sources.

