

## KT10303DBHOB

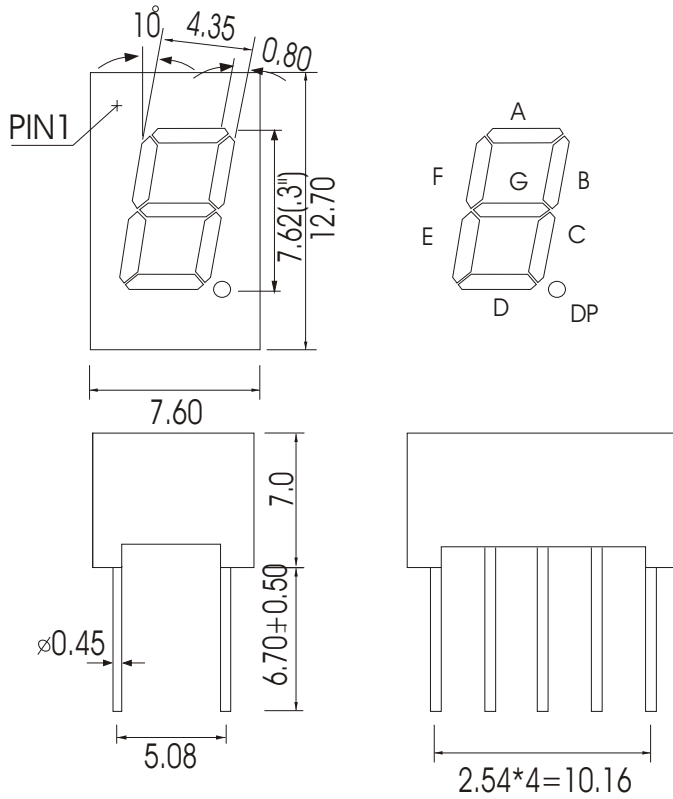

### Features

- 0.30 inch digit height
- Low power requirement
- I.C. Compatible
- Easy assembly
- RoHs compliant
- Wide viewing angle
- End stack able
- Gray surface
- White segments
- Common Cathode

## CODE D

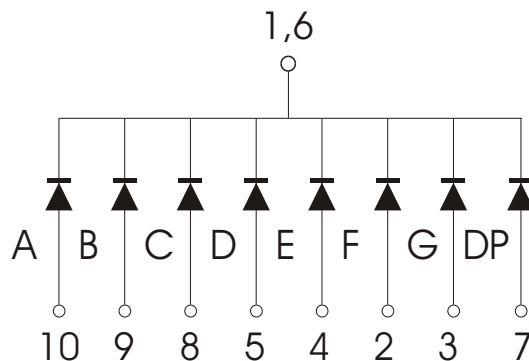

Notes: 1. All dimensions are in millimeter (inches), tolerance is 0.25mm unless otherwise noted.  
2. Specifications are subject to change without notice.

### Code: BH High Blue (Gan)

Parameter	Symbol	Condition	Min.	Typ.	Max.	Unit
Forward Voltage (Per dice)	V <sub>f</sub>	I <sub>f</sub> =20mA	3.0		3.6	V
Reverse Voltage (Per dice)	V <sub>r</sub>	I <sub>r</sub> =10uA		5		V
Luminous Intensity (Per dice)	I <sub>v</sub>	I <sub>f</sub> =20mA		35.0		mcd
Spectrum Width Of Half Value	Δλ	I <sub>f</sub> =20mA		22		nm
Wavelength	Dλ	I <sub>f</sub> =20mA		477		nm
Peak Forward Current (Per dice) 1/10 Duty Cycle, 0.1ms Pulse	I <sub>fp</sub>		100			mA
Operating Temperature Range	T <sub>opr</sub>		- 35 °C to 85 °C			
Storage Temperature Range	T <sub>stg</sub>		- 35 °C to 85 °C			

Solder Temperature 1.5mm below seating plane for 3 Seconds at 260 °C

Absolute Maximum Rating at Ta=25°C

Fig.1



Fig.2



Fig.3



Fig.4



### Wave Soldering for Lead-Free Through-hole LED



1.5mm below package base

Solder Temperature	260°C for 5 Seconds
--------------------	---------------------

### Lead-free SMT process



Lead solder Temperature	235°C for 5 Seconds
-------------------------	---------------------

Notes: Recommend the wave temperature max. 235 °C.

Do not apply stress on the epoxy when temperature over 80 °C.

No more than once.