

KT10501BWHOB

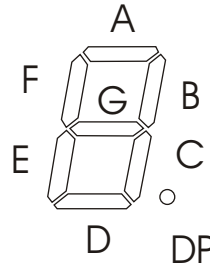

Features

- 0.50 inch digit height
- Low power requirement
- I.C. Compatible
- Easy assembly
- RoHs compliant
- Wide viewing angle
- End stack able
- Gray surface
- White segments
- Common Anode

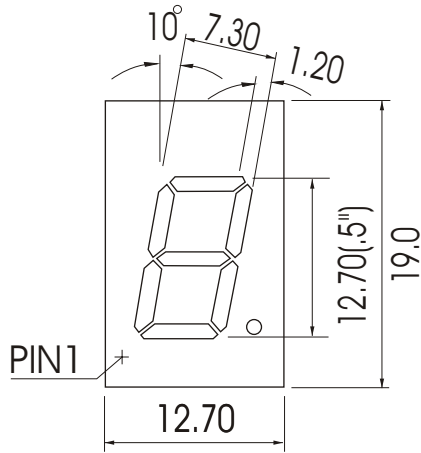
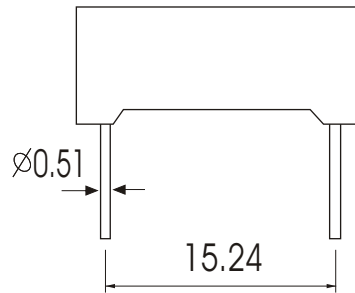
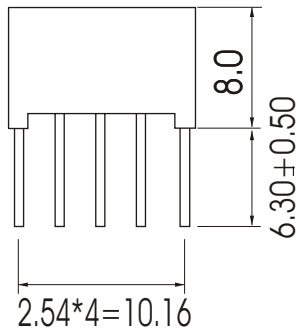

CODE B

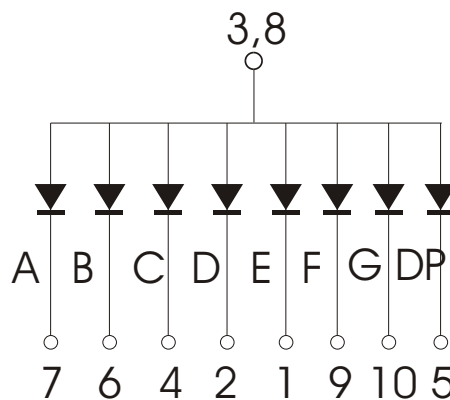

Notes: 1. All dimensions are in millimeter (inches), tolerance is 0.25mm unless otherwise noted.
2. Specifications are subject to change without notice.

Code:WH White (AlInGaN)

Parameter	Symbol	Condition	Min.	Typ.	Max.	Unit
Forward Voltage (Per dice)	Vf	If=20mA	3.1	3.3	3.6	V
Reverse Voltage (Per dice)	Vr	Ir=40uA		5		V
Luminous Intensity (Per dice)	Iv	If=20mA		200		mcd
Chromaticity Coordinates	X	If=20mA		0.29		nm
Chromaticity Coordinates	Y	If=20mA		0.30		nm
Peak Forward Current (Per dice) 1/10 Duty Cycle,0.1ms Pulse	Ifp		100			mA
Operating Temperature Range	Topr		- 35 °C to 85 °C			
Storage Temperature Range	Tstg		- 35 °C to 85 °C			
Solder Temperature 1.5mm below seating plane for 3 Seconds at 260 °C						

Absolute Maximum Rating at Ta=25°C

Fig.1



Fig.2

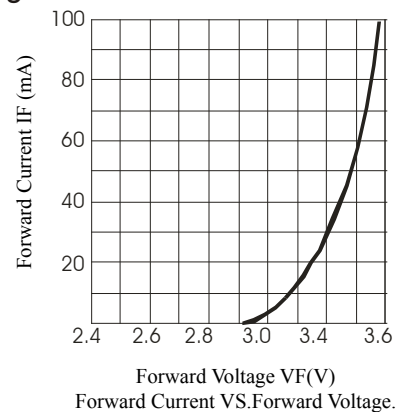

Fig.3

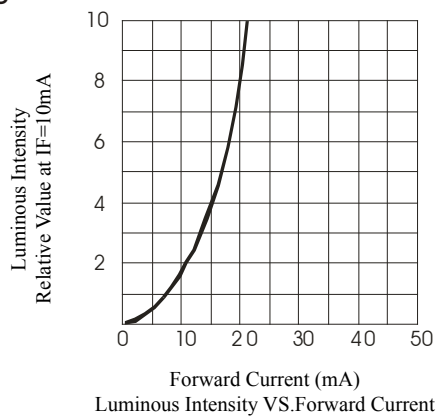
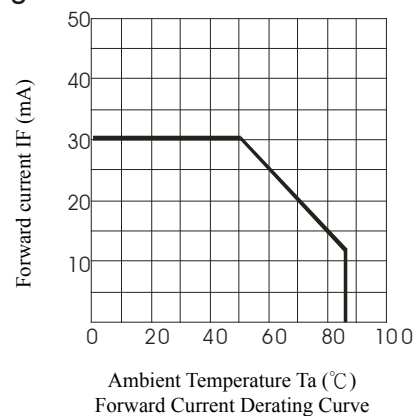

Fig.4



Wave Soldering for Lead-Free Through-hole LED



1.5mm below package base

Solder Temperature	260°C for 5 Seconds
--------------------	---------------------

Lead-free SMT process



Lead solder Temperature	235°C for 5 Seconds
-------------------------	---------------------

Notes: Recommend the wave temperature max. 235 °C.
 Do not apply stress on the epoxy when temperature over 80 °C.
 No more than once.