

KTM10R

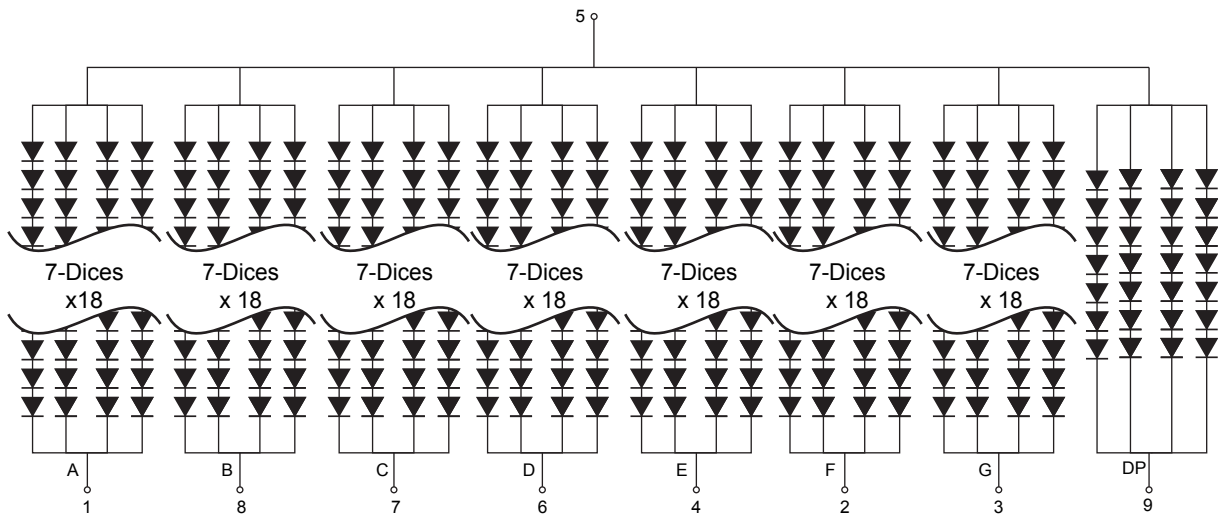

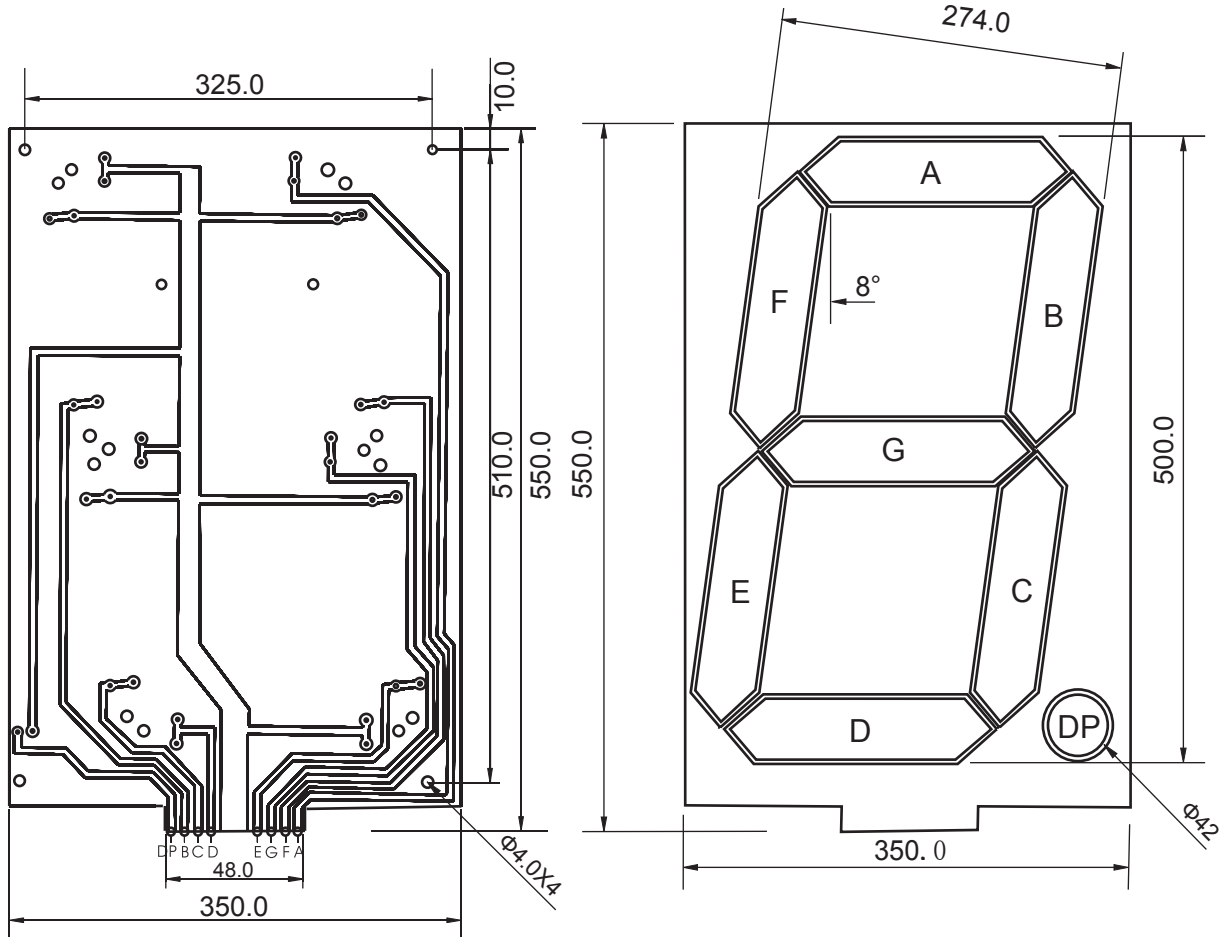
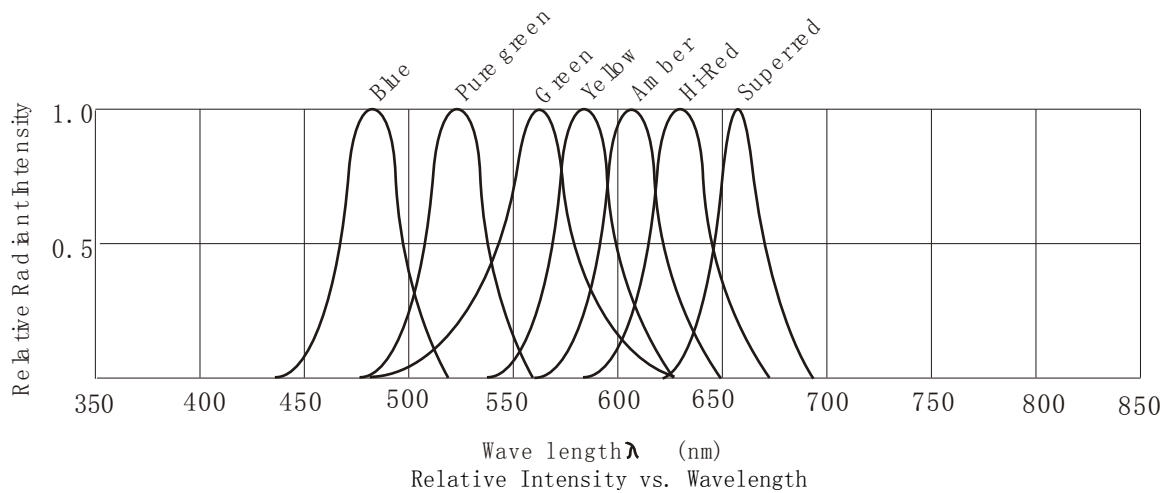

SEGMENT

Parameter	Symbol	Condition	Min.	Typ .	Max.	Unit
Forward Voltage	V _f	I _f =350mA	13.5		14.5	V
Reverse Voltage	V _r	I _r =10uA	5.0			V
Luminous Intensity	I _v	I _f =350mA	7.94			cd
Spectrum With Of Half Value	Δλ	I _f =350mA	22			nm
Wavelength	D λ	I _f =350mA	623	626	628	nm
Operating Temperature Range		-35°C to 85°C				
Storage Temperature Range		-35°C to 85°C				
Solder Temperature 1.5mm below seating plane for 3 Seconds at 260°C						

DOT

Parameter	Symbol	Condition	Min.	Typ .	Max.	Unit
Forward Voltage	V _f	I _f =80mA	13.5		14.5	V
Reverse Voltage	V _r	I _r =10uA	5.0			V
Luminous Intensity	I _v	I _f =80mA	7.94			cd
Spectrum With Of Half Value	Δλ	I _f =80mA	22			nm
Wavelength	D λ	I _f =80mA	623	626	628	nm
Operating Temperature Range		-35 C to 85°C				
Storage Temperature Range		-35°C to 85°C				
Solder Temperature 1.5mm below seating plane for 3 Seconds at 260°C						

Absolute Maximum Rating at T_a=25°C

Wave Soldering for Lead-Free Through-hole LED

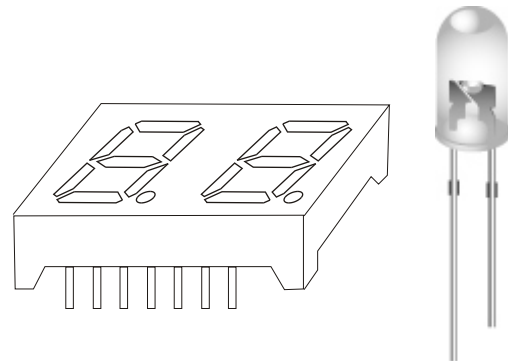
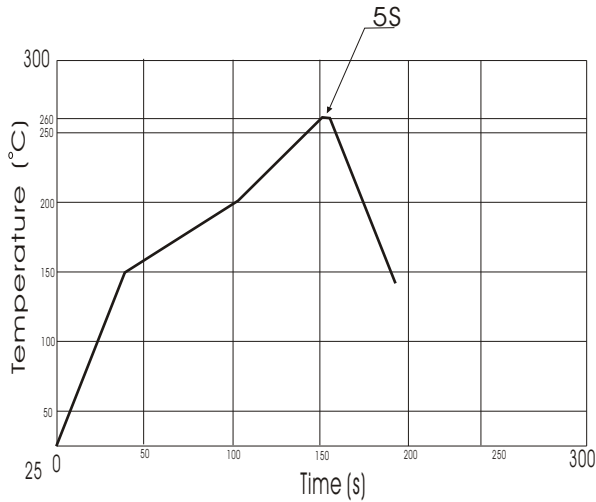

1.5mm below package base

Solder Temperature	260°C for 3 Seconds
--------------------	---------------------

Lead-free SMT process

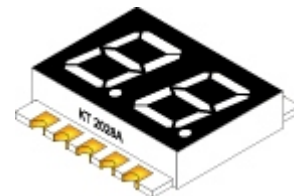
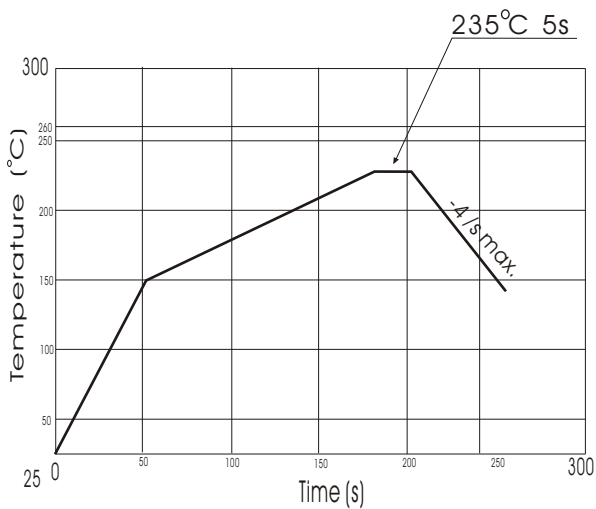

Lead solder Temperature	235°C for 5 Seconds
-------------------------	---------------------

Notes: Recommend the wave temperature max. 235°C.
 Do not apply stress on the epoxy when temperature over 80°C.
 No more than once.